

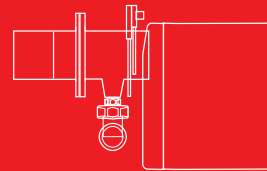

Riello 40 GS/M Series

Two Stage Progressive and Modulating Gas Burners

GS10/M	22/42 ÷ 105	kW
GS20/M	43/82 ÷ 194	kW

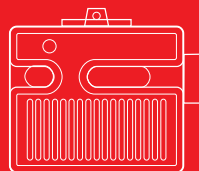

The Riello 40 GS/M series of two stage progressive or modulating gas burners, is a complete range of products developed to respond to any request of gas burners for hot air generator according to EN 1020. These new models complete the Riello 40 gas series which prides itself on many years of experience in all the world in the field of residential heating and soft industrial applications. This series of burners is available in two different models with an output ranging from 22 to 194 kW, divided in two different structures.

Basic version of these models has two stage progressive operation. A simple modification, adding a component, permits obtaining modulating operation with a rate 1 : 4. The burners are supplied air fuel ratio control gas trains.

This more advanced version can better satisfy market needs for applications where modulation is requested to obtain highest plant efficiency.

In developing these burners, special attention was paid to the ease of installation and adjustment, to maintaining the smallest size possible and obtaining high performance for modulating operation to fit into any sort of application available on the market. All the models are approved by the EN 676 European Standard and they conform to European Directives: Gas Appliances, EMC, Low Voltage and Boiler Efficiency.

Technical Data

MODEL			GS 10/M	GS 20/M
Burner operation mode			Modulating (with regulator and probes accessories)	
Modulation ratio at max. output			1 ÷ 4	
Servomotor		type	LANDIS	
		run time s	30	
Heat output		kW	22/42 ÷ 105	43/82 ÷ 194
		Mcal/h	18.9/36.1 ÷ 90.3	37/70.5 ÷ 166.8
Working temperature		°C min./max.	0/40	
FUEL/AIR DATA				
G20 gas	net calorific value	kWh/Nm ³	10	
	gas density	kg/Nm ³	0.71	
	gas delivery	Nm ³ /h	2.2/4.2 ÷ 10.5	4.3/8.8 ÷ 19.4
G25 gas	net calorific value	kWh/Nm ³	8.6	
	gas density	kg/Nm ³	0.78	
	gas delivery	Nm ³ /h	2.55/4.88 ÷ 12.2	4.9/5.53 ÷ 23.65
LPG gas	net calorific value	kWh/Nm ³	25.8	
	gas density	kg/Nm ³	2.02	
	gas delivery	Nm ³ /h	0.85/1.63 ÷ 4.07	1.67/3.18 ÷ 7.52
Fan		type	Forward blades	
Air temperature		max °C	60	
ELECTRICAL DATA				
Electrical supply		Ph/Hz/V	1/50/230 (±10%)	
Auxiliary electrical supply		Ph/Hz/V	--	
Control box		type	LANDIS LMG 22	
Total electrical power		kW	0.13	0.25
Auxiliary electrical power		kW	--	
Protection level		IP	X0D	
Fan motor	electrical power	kW	0.09	0.15
	rated current	A	0.7	1.3
	start up current	A	2.8	5.2
	protection level	IP	20	
Ignition transformer		type	Separated from the control box	
		V1 - V2	230V - 1x15 kV	
		I1 - I2	0.2 A - 25 mA	
Operation			Intermittent (at least one stop every 24 h)	
EMISSIONS				
Noise levels	sound pressure	dB (A)	65	72
	sound power	W	76	83
Gas G20	CO emission	mg/kWh	30	30
	NOx emission	mg/kWh	100	110
APPROVAL				
Directive			2006/42/EC - 2009/142/EC - 2014/30/UE - 2014/35/UE	
Conforming to			EN 676 - EN 12100	
Certification			CE-0085BM0453	

Reference conditions:

Temperature: 20°C - Pressure: 1013,5 mbar - Altitude: 0 m a.s.l. - Noise measured at a distance of 1 meter.

Since the Company is constantly engaged in the production improvement, the aesthetic and dimensional features, the technical data, the equipment and the accessories can be changed. This document contains confidential and proprietary information of RIELLO S.p.A. Unless authorised, this information shall not be divulged, nor duplicated in whole or in part.

Firing Rates

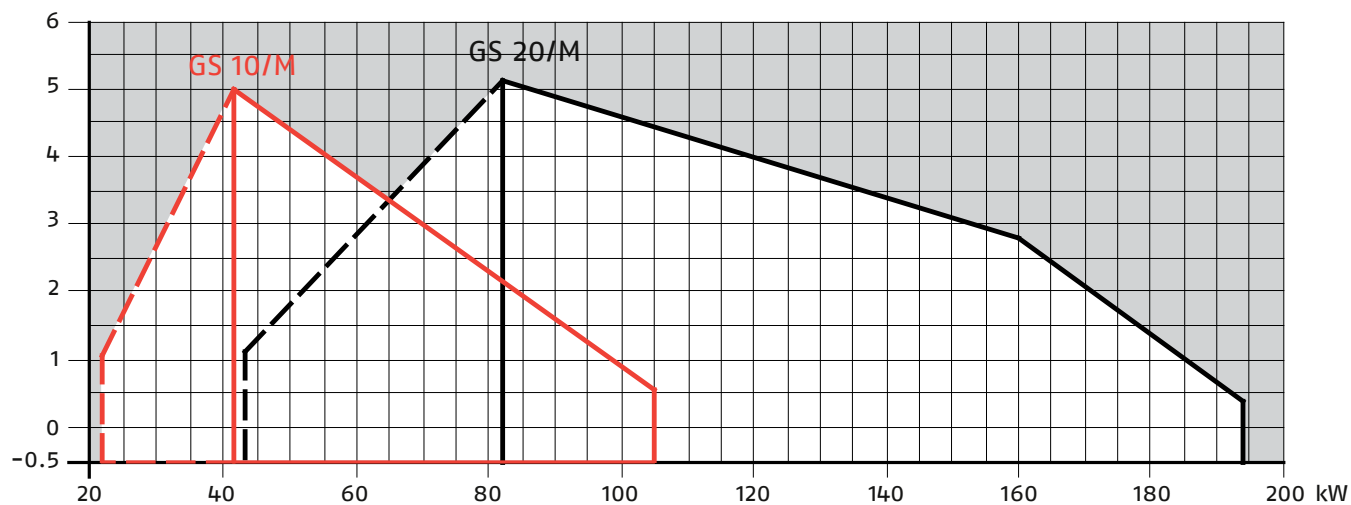

 Useful working field for choosing the burner

 Modulation range

Test conditions conforming to EN 676:

Temperature: 20°C

Pressure: 1013,5 mbar

Altitude: 0 m a.s.l.

Gas train

GAS TRAIN DESIGNATION

Series: MB

Size: 407 412

Operation: /P stage mode opening

Leak detection control: - 0

Joint type: R threaded joint
 F1 square flange BS1
 F2 square flange BS2
 F3 square flange BS3 - BS4

Electrical connection: SD Domestic plug

Standard output pressure range:

- without pressure governor
- 0 with governor and air/gas proportional pressure
- 2 with governor and output pressure up to 20 mbar
- 3 with governor and output pressure up to 30 mbar
- 4 with governor and output pressure up to 40 mbar
- 5 with governor and output pressure up to 50 mbar

Valve control: 0 shared

MB	412	/P	-	R	SD	0	0
----	-----	----	---	---	----	---	---

BASIC DESIGNATION

EXTENDED DESIGNATION

GAS TRAINS

The burners are set for fuel supply from either the right or left hand sides. Depending on the fuel output and the available pressure in the supply line, you should check the correct gas train to be adapted to the system requirements.

The gas train is Multibloc type, containing the main components in a single unit. A valve seal control (as accessory) can be fitted to the Multibloc gas trains.

MB 407–412/P

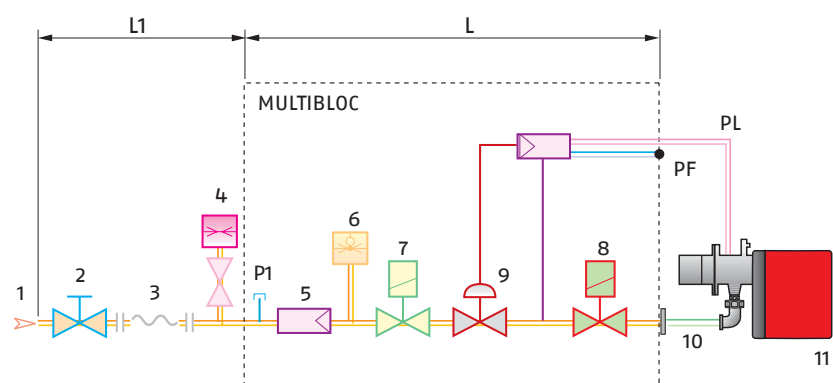

1	Gas input pipework
2	Manual valve (charged to the installer)
3	Antivibrating joint
4	Gas pressure gauge
5	Gas filter
6	Min. gas pressure switch
7	Safety gas valve
8	Gas valve
9	Gas regulator
10	Burner
PF	Impulse line combustion chamber
PL	Impulse line combustion head
P1	Gas pressure gauge
L	Gas train supplied separately
L1	Installer's responsibility

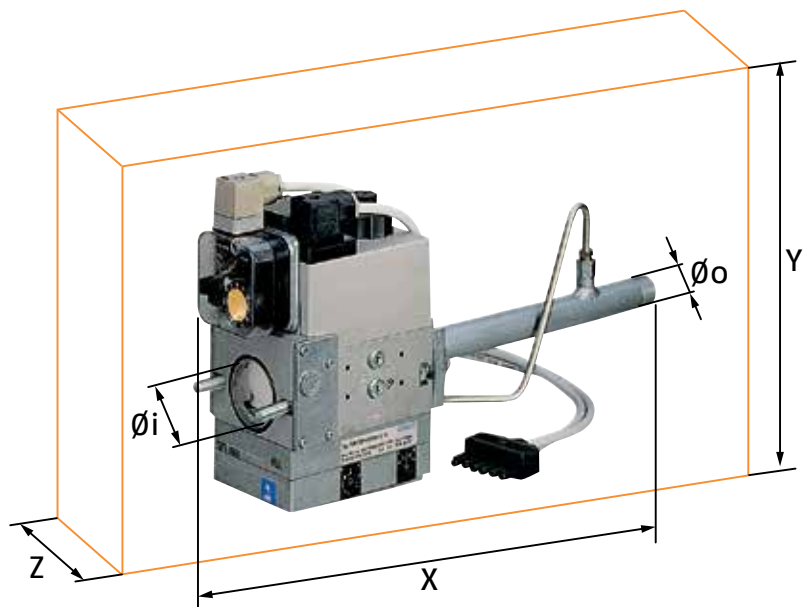

The following table shows the dimensions of the gas trains which can be fitted to Riello 40 GS/M burners, intake diameter and the coupling flange to the burner.

GAS TRAIN							
MODEL	CODE	Ø in	Ø out	X mm	Y mm	Z mm	mbar max*
MB 407/P	3970535	Rp 3/4"	Rp 3/4"	430	230	120	100
MB 412/P	3970536	Rp 1"	Rp 3/4"	465	255	145	100

* max inlet gas pressure (mbar)

Pressure Drop Diagram

The diagrams indicate the minimum pressure drop of the burners with the various gas trains that can be matched with them; at the value of these pressure drop add the combustion chamber pressure. The value thus calculated represents the minimum required input pressure to the gas train.

GS10/M (NATURAL GAS)

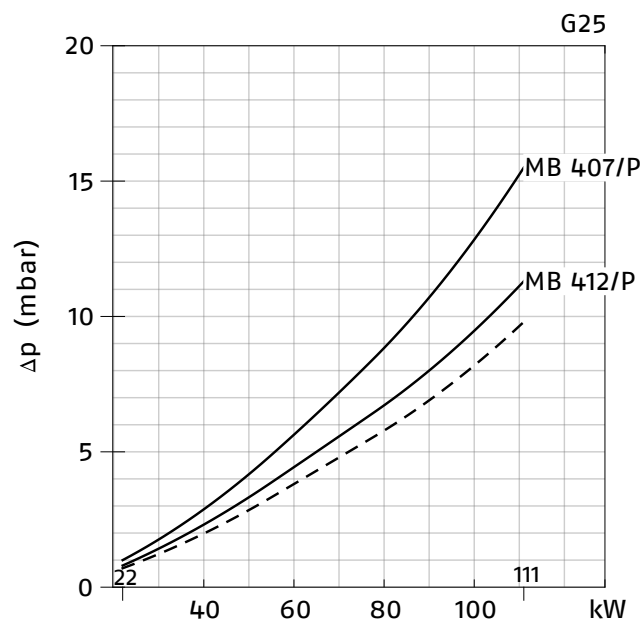
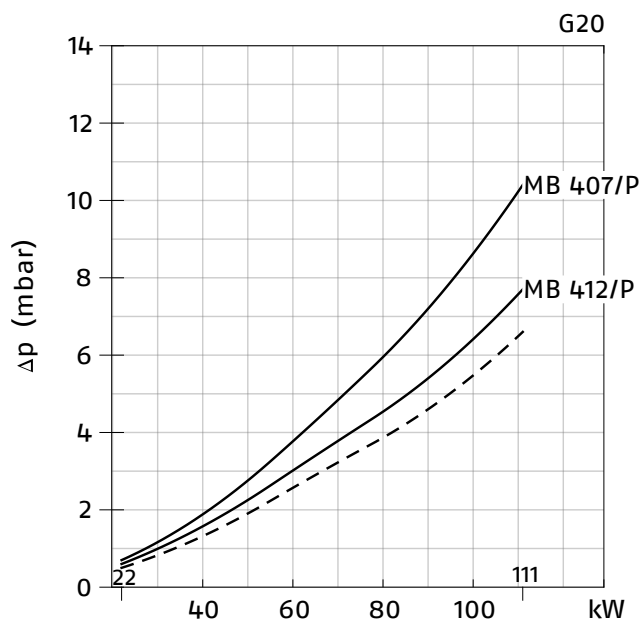

GS10/M (LPG)

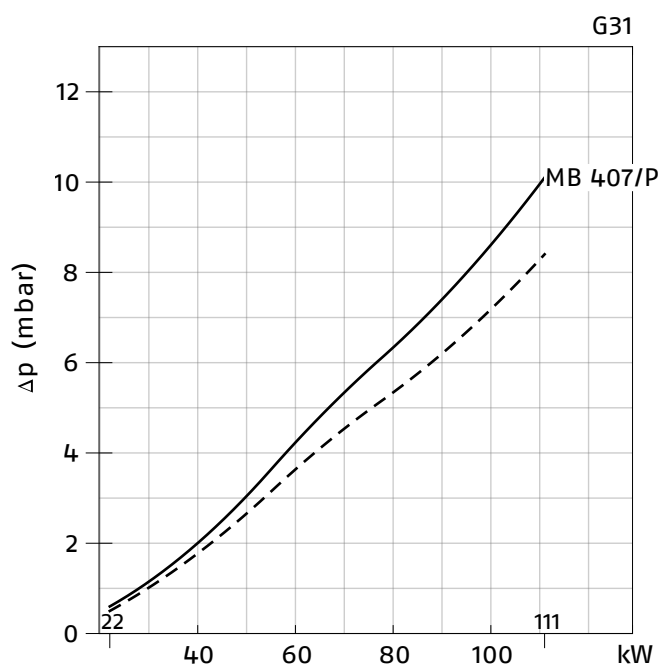

For pressure levels different from those indicated above, please contact Riello Burners Technical Office.
 In LPG plants, Multibloc gas trains do not operate below 0°C.
 They are only suitable for gaseous LPG (liquid hydrocarbons destroy the seal materials).

- Combustion head + gas train
- - - Combustion head

GS20/M (NATURAL GAS)

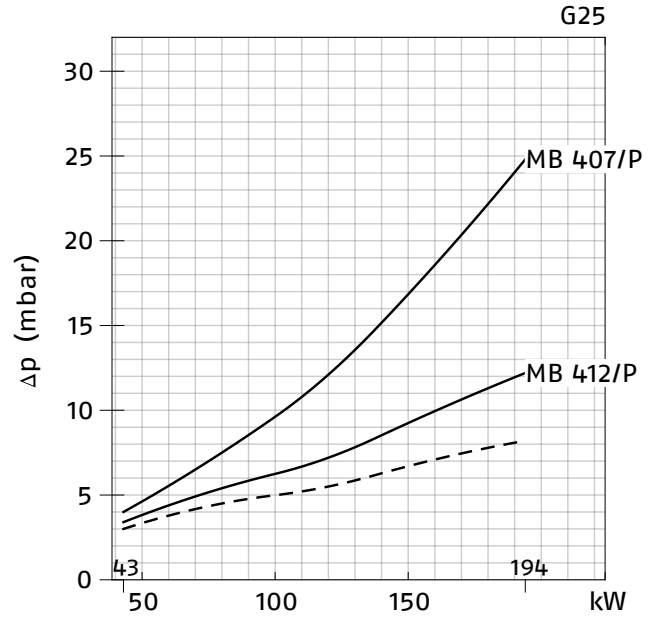
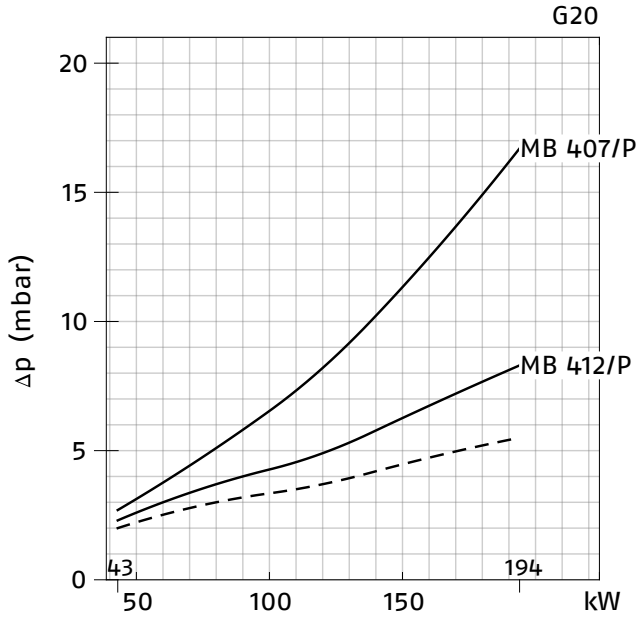

GS20/M (LPG)

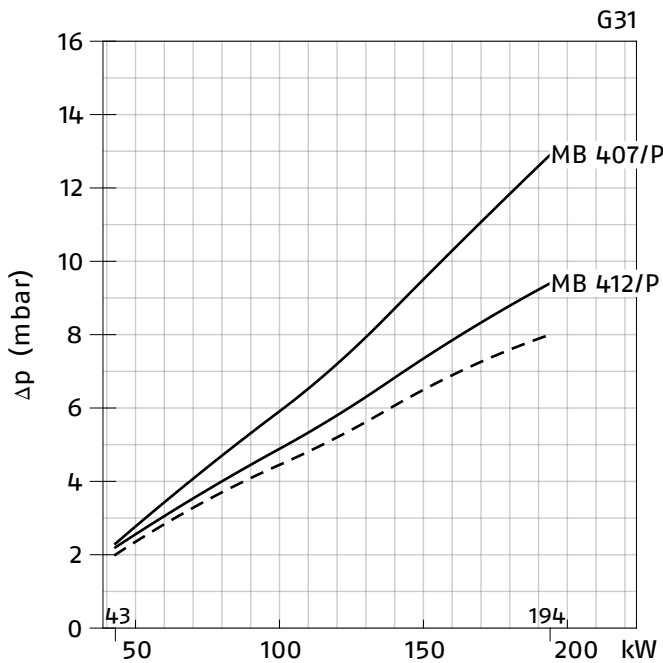

For pressure levels different from those indicated above, please contact Riello Burners Technical Office.
 In LPG plants, Multibloc gas trains do not operate below 0°C.
 They are only suitable for gaseous LPG (liquid hydrocarbons destroy the seal materials).

- Combustion head + gas train
- - - Combustion head

Ventilation

The different ventilation circuits always ensure low noise levels with high performance of pressure and air delivery, inspite of their compact size. The burners are fitted with an adjustable air pressure switch, conforming to EN 676 Standards.



Air suction

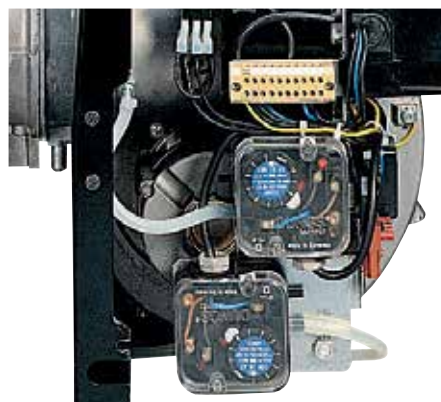

Min and max air pressure switches

Combustion Head

The combustion head in Riello 40 GS/M Heater burners is the result of an innovative design, which allows combustion with low polluting emissions, while being easy to adapt to all the various types of boilers and combustion chambers.



Combustion head



Mobile flange

DIMENSIONS OF THE FLAME

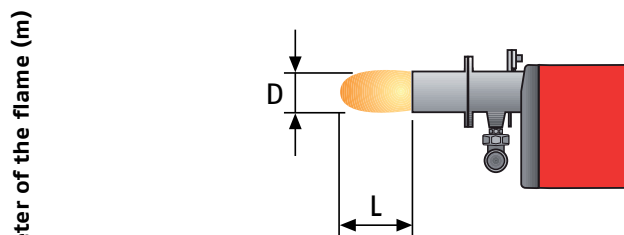
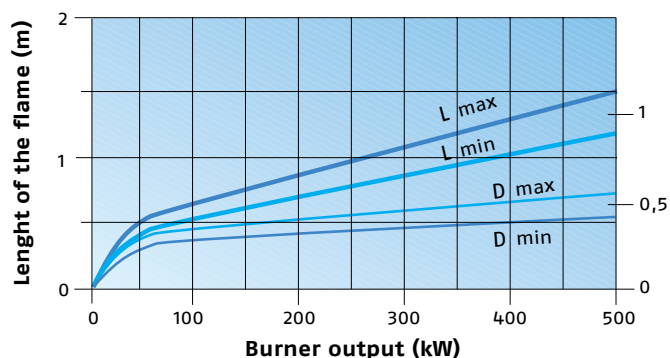

Example:
 Burner thermal output = 350 kW;
 L flame (m) = 1.2 m (medium value);
 D flame (m) = 0.6 m (medium value)

Operation

BURNER OPERATION MODE

All these models in standard version are two-stage progressive operation. Adding the output regulator device they are modulating operation.

On "two-stage progressive" operation, the burner gradually adapts the output to the requested level, by varying between two pre-set levels.

On "modulating" operation, normally required in steam generators, in superheater boilers or diathermic oil burners, a specific regulator and probes are required. These are supplied as accessories that must be ordered separately. The burner can work for long periods at intermediate output levels.

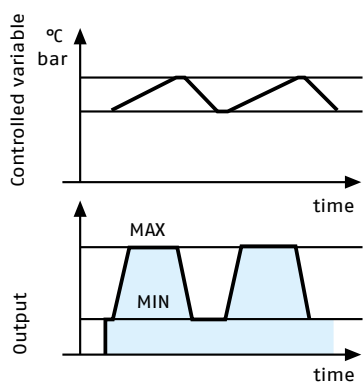

Two stage progressive" operation

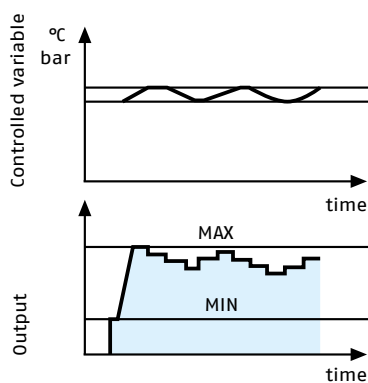

"Modulating" operation



Air damper adjustment

START UP CYCLE

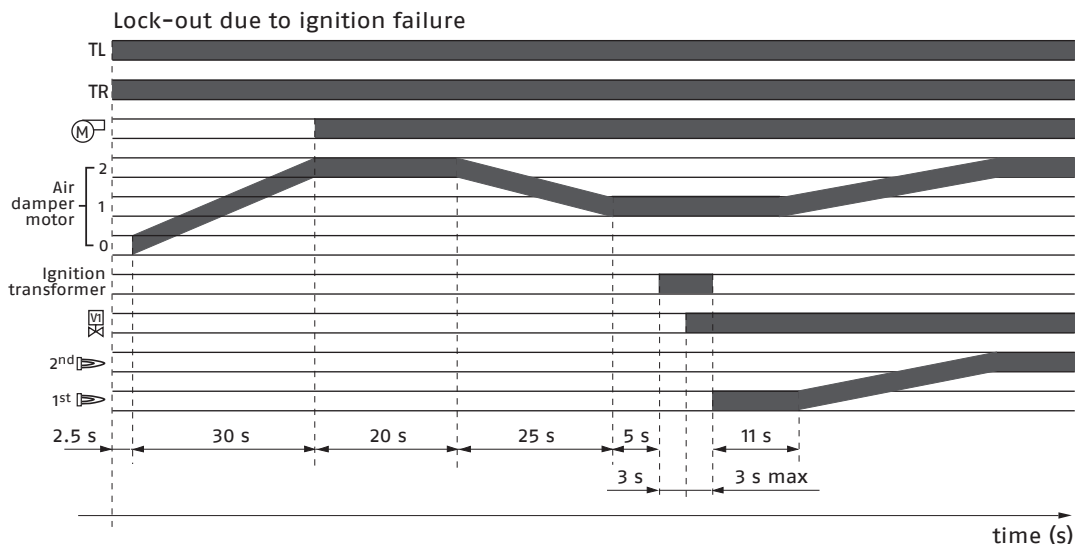

- 0s The burner begins the ignition cycle.
- 0s ÷ 2,5s Safety time.
- 2.5s ÷ 32.5s Progressive open of the air damper until the 2nd stage position.
- 32.5s ÷ 52.5s Pre-purge at the 2nd stage.
- 52.5s ÷ 77.5s The air damper closes until 1st stage position.
- 77.5s ÷ 82.5s Pre-purge at the 1st stage.
- 82.5s ÷ 88.5s The ignition transformer starts.
- 85.5s The solenoid opens.
- 88.5s ÷ 99.5s Ignition 1st stage.
- 99.5s Ignition 2nd stage.

If the flame does not light within the safety limit (~3s) the burner locks-out. Lock-out is shown by a led on the appliance.

Emissions

The emission data have been measured in the various models at maximum output, in conformity with EN 676 standard.

NO2 EMISSIONS

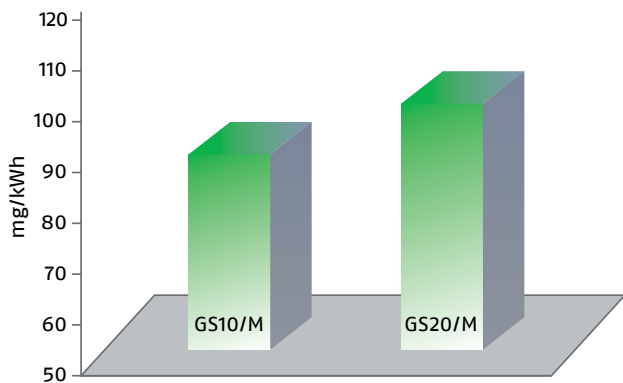

CO EMISSIONS (gas G20)

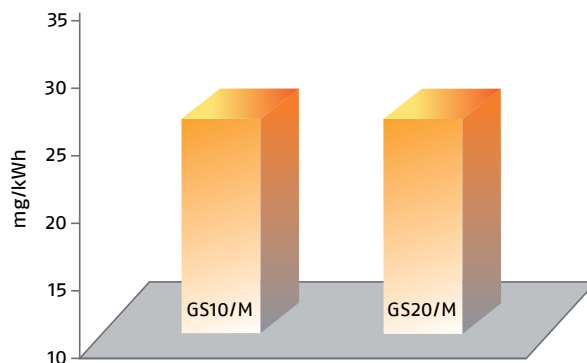

NOISE EMISSIONS

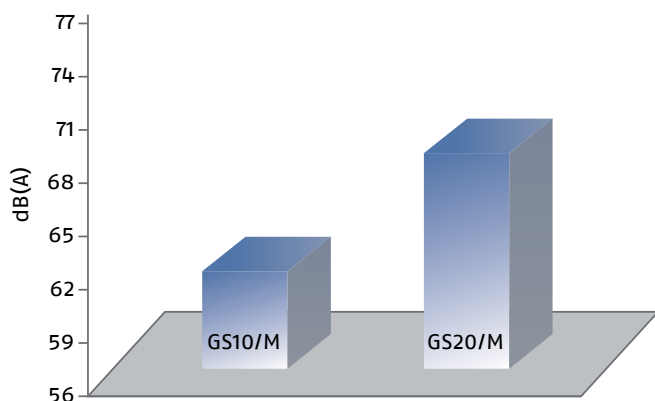

Special attention has been paid to noise reduction. All models are fitted with sound-proofing material inside the cover.



Overall Dimensions (mm)

These models are distinguished by their reduced size, in relation to the outputs achieved, which means they can be fitted to any boiler on the market.

BURNER

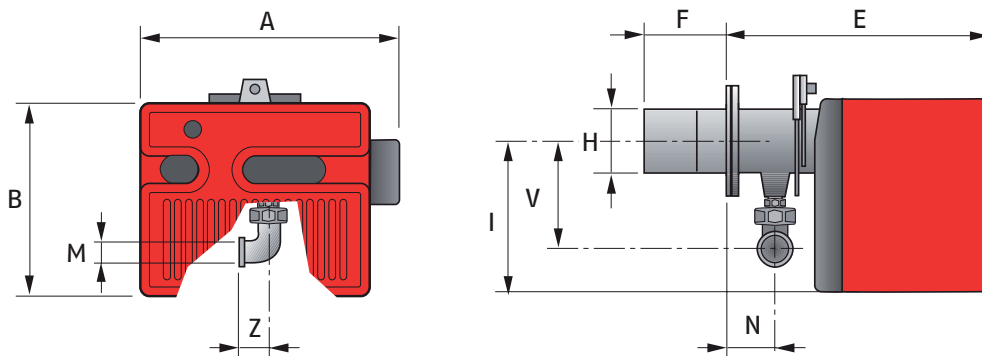

MODEL	A	B	E	F	H	I	M	N	V	Z
GS 10/M	425	262	347	128	105	204	Rp 3/4"	61	142	33
GS 20/M	488	298	389	142.5	125	230	Rp 3/4"	67	152	33

BURNER - BOILER MOUNTING FLANGE

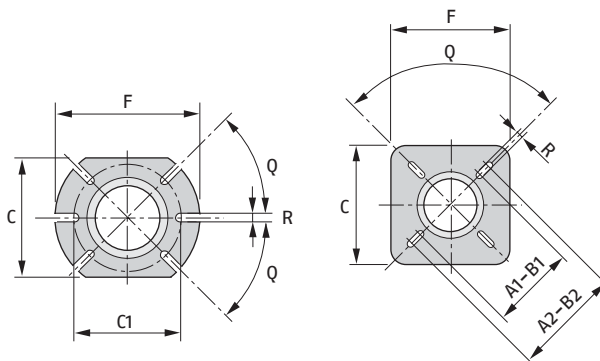

MODEL	A1	A2	B1	B2	C	C1	F	Q	R
GS 10/M	-	-	-	-	160	130	185	45	11
GS 20/M	155	200	155	200	170	-	170	90	11

PACKAGING

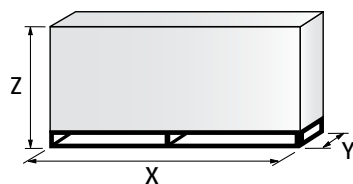

MODEL	X	Y	Z	kg
GS 10/M	505	490	330	17
GS 20/M	560	535	375	17

Installation Description

Installation, start up and maintenance must be carried out by qualified and skilled personnel. All operations must be performed as described in the technical handbook supplied with the burner. The burner is set in the factory on standard calibration (minimum output). If necessary adjustments can be made on the basis of the maximum output of the boiler.

BURNER SETTING

The gas flow rate for both high and low capacity must be done by using the adjustment screws **V** and **N** on the gas valve group.

The air flow must be adjusted at maximum output by the air damper.

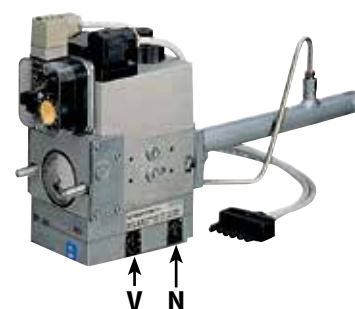

If necessary it is possible to increase the minimum output by moving a cam of the air servomotor.

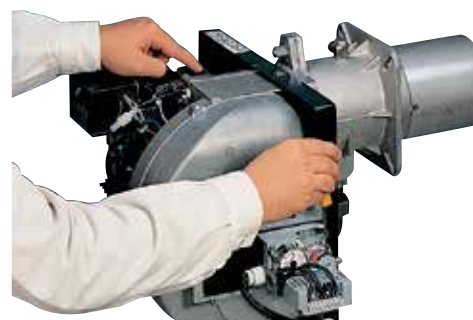

In accordance with EN 676 and EN 1020, the GS 10/M and GS 20/M are provided with two air pressure switches to be adjusted at the end of the commissioning procedure.

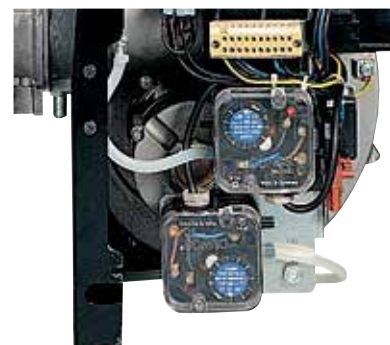

MAINTENANCE

Particular care is given to the design of the burner to ensure ease of maintenance. The burner body is hinged to permit quick and easy access to the combustion head for maintenance and setting.

To make friendly all the operations on the burner, the internal and external components are connected by plugs and sockets.



Burner accessories

EXTENDED HEAD KIT

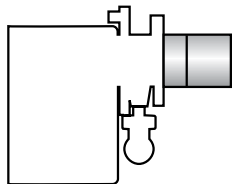

Burners standard head can be transformed into “extended head” versions by using the special kit. Here the KITS available for the various burners are listed, showing the original and the extended lengths.

BURNER	STANDARD HEAD LENGTH (mm)	EXTENDED HEAD LENGTH (mm)	CODE
GS 10/M	128	188	3001064
GS 20/M	120	280	3000873

END CONE WITH TURBULATOR DISK



The end cone turbulator disk reduces the flame length. It is suitable for hoven application (CO emissions) and short boiler chamber.

BURNER	PROJECTION (mm)	CODE
GS 10/M	+18	3000918
GS 20/M	+23	3000919

LPG KIT

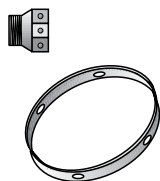

For burning LPG gas, a special kit is available to be fitted to the combustion head on the burner, as shown in the following table.

BURNER	STANDARD HEAD CODE	EXTENDED HEAD CODE
GS 10/M	3000884	3000884
GS 20/M	3000886	3000886

GROUND FAULT INTERRUPTER KIT



A “Ground fault interrupter kit” is available as a safety device in case of electrical system fault. It is supplied with burners with pin plug.

BURNER	CODE
GS 10/M – GS 20/M	3001180

7-PIN PLUG KIT

If necessary a 7-pin plug kit is available (in packaging of n. 5 pieces).

BURNER	CODE
GS 10/M – GS 20/M	3000945

ACCESSORIES FOR MODULATING OPERATION



To obtain modulating operation, the BS/M series of burners requires a regulator with three point outlet controls. The following table lists the accessories for modulating operation with their application range.

BURNER	REGULATOR TYPE	CODE
GS 10/M – GS 20/M	RWF50.2	20105193
	RWF50.5	20105274



The relative temperature or pressure probes fitted to the regulator, must be chosen on the basis of the application.

BURNER	PROBE TYPE	RANGE (°C) (bar)	CODE
GS 10/M – GS 20/M	Temperature PT 100	-100 ÷ 500°C	3010110
	Pressure 4 ÷ 20 mA	0 ÷ 2,5 bar	3010213
	Pressure 4 ÷ 20 mA	0 ÷ 16 bar	3010214

PC INTERFACE KIT



To connect the control box to a personal computer for the transmission of operation, fault signals and detailed service information, an interface adapter with PC software are available.

BURNER	CODE
GS 10/M – GS 20/M	3002719

Specification

DESIGNATION OF SERIES

A specific index guides your choice of burner from the various models available in the GS/M series. Below is a clear and detailed specification description of the product.

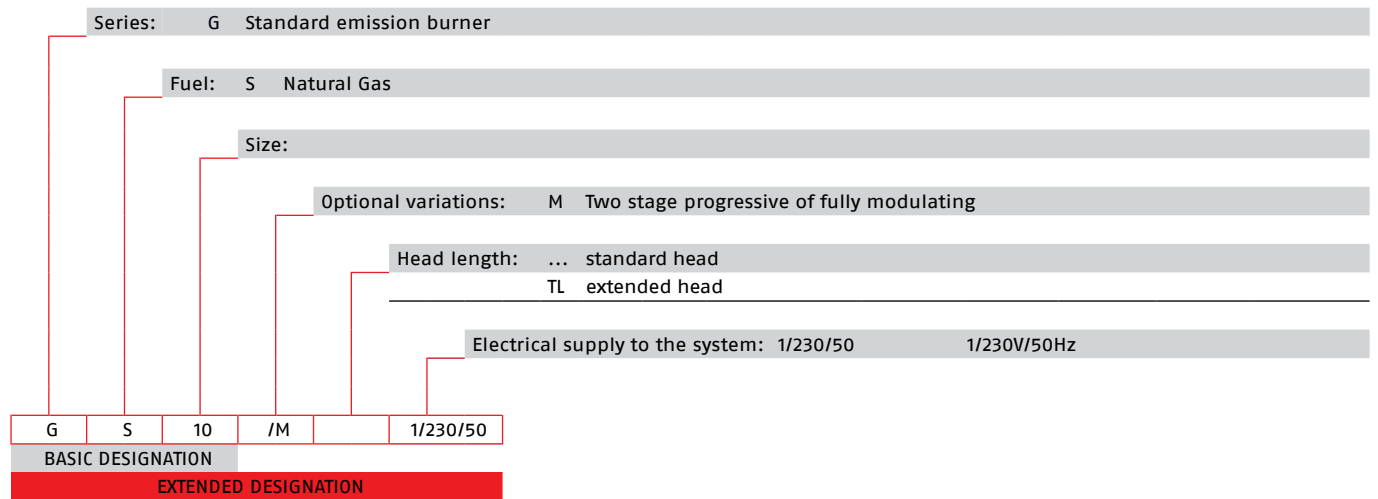

AVAILABLE BURNER MODELS

BURNER MODELS	ELECTRICAL SUPPLY	HEAT OUTPUT		TOTAL ELECTRICAL POWER (kW)	CERTIFICATION	NOTE
		(kW)	NATURAL GAS (Nm ³ /h)			
GS10/M	1/230/50	22/42 ÷ 105	2.2/4.2 ÷ 10.5	0.13	CE-0085BM0453	(1)
GS20/M	1/230/50	43/82 ÷ 194	4.3/8.2 ÷ 19.4	0.25	CE-0085BM0453	(1)
GS10/M	1/220/60	22/42 ÷ 105	2.2/4.2 ÷ 10.5	0.13		(1)
GS20/M	1/220/60	43/82 ÷ 194	4.3/8.2 ÷ 19.4	0.25		(1)

Net calorific value G20: 10 kWh/Nm³ – Density: 0,71 kg/Nm³.
 The burners of GS/M series are in according to EN 676.
 (1) With plug and socket.

SPECIFICATION

STATE OF SUPPLY

Burner

Monoblock, gas burners, completely automatic, high/low progressive operation mode or fully modulating by using a regulator:

- Ratio air/fuel controlled by checking both the air and the gas flows
- Two pressure switches on the burner, to make sure the burner operation, detecting both the fan and the chimney functions
- Remote reset available
- Servomotor to drive the air damper to fully closed position at stand-by, low and high fire position
- Turn down fire 1:4
- Fan with forward inclined blades
- Metallic cover
- Single phase electric motor 230 V, 50 Hz
- Combustion head fitted with:
 - stainless steel head cone, resistant to high temperatures
 - ignition electrodes
 - ionisation probe
 - gas distributor
 - flame stability disk
 - additional device, to keep short the flame shape
- Protection filter against radio interference
- IP X0D (IP 40) electric protection level.

Standard equipment:

- Hinge to turn the burner left-side or right-side for the maintenance position
- Flange insulation screen
- Screws and nuts for fixing the flange to the boiler
- 7-pin plug with capacitor for EMC
- 4-pin plug to connect the high-low thermostat
- Instruction handbook for installation, use and maintenance
- Spare parts catalogue

Conforming to:

- 2014/30 UE Directive (electromagnetic compatibility)
- 2014/35 UE Directive (low voltage)
- 2009/142 EC Directive (gas)
- 2006/42 EC Directive (machine)
- EN 676 (gas burners)

Available accessories to be ordered separately:

- Extended head kit
- End cone with turbulator disk
- LPG kit
- Ground fault interrupter kit
- 7-pin plug kit
- Accessories for modulating operation (RWF 40, temperature and pressure probe)
- PC interface kit

Riello Burners a world of experience in every burner we sell.

05/2016

TS0011UK03



[1]

Across the world, Riello sets the standard in reliable and high efficiency burner technology.

With burner capacity from 5 kW to 48 MW, Riello gas, oil, dual fuel and Low Nox burners deliver unbeatable performance across the full range of residential and commercial heating applications, as well as in industrial processes.

With headquarter in Legnago, Italy, Riello has been manufacturing premium quality burners for over 90 year. The manufacturing plant is equipped with the most innovative systems of assembling lines and modern manufacturing cells for a quick and flexible response to the market.

Besides, the Riello Combustion Research Centre, located in Angiari, Italy, represents one of the most modern facility in Europe and one of the most advanced in the world for the development of the combustion technology.

Today, the company's presence on worldwide markets is distinguished by a well-constructed and efficient sales network, alongside many important Training Centres located in various countries to meet its customers' needs. Riello has 13 operational branches abroad (in Europe, America and Asia), with customers in over 60 countries.



[2]

[1] BURNERS PRODUCTION PLANT
S. PIETRO, LEGNAGO (VERONA) - ITALIA

[2] HEADQUARTER BURNERS DIVISION
S. PIETRO, LEGNAGO (VERONA) - ITALIA

RIELLO S.p.A. - 37045 Legnago (VR) - Italy
tel. +39 0442 630111 - fax: +39 0442 21980
www.riello.com

Since the Company is constantly engaged in the production improvement, the aesthetic and dimensional features, the technical data, the equipment and the accessories can be changed. This document contains confidential and proprietary information of RIELLO S.p.A. Unless authorised, this information shall not be divulged, nor duplicated in whole or in part.

RIELLO